

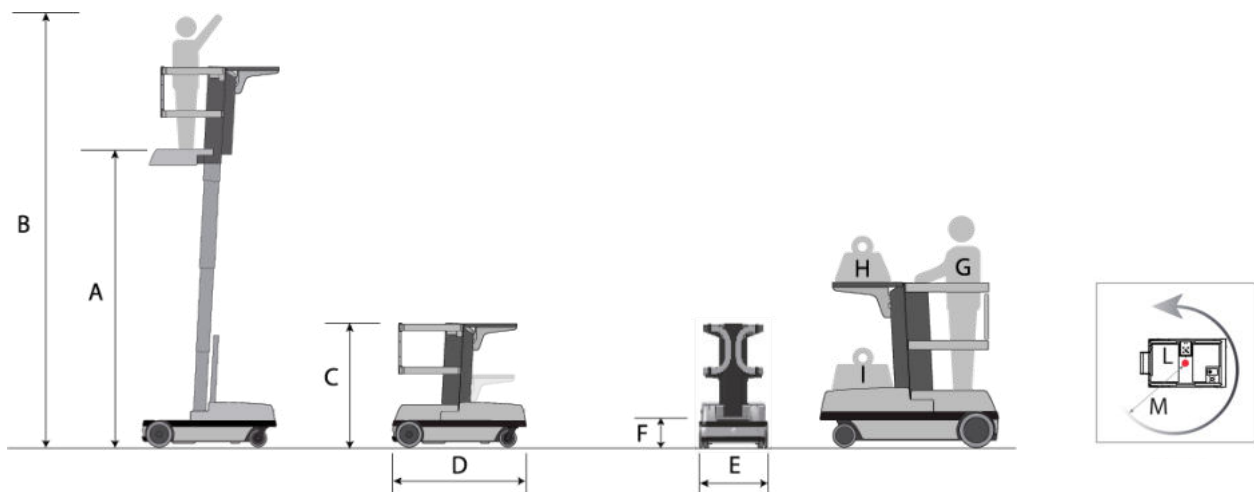















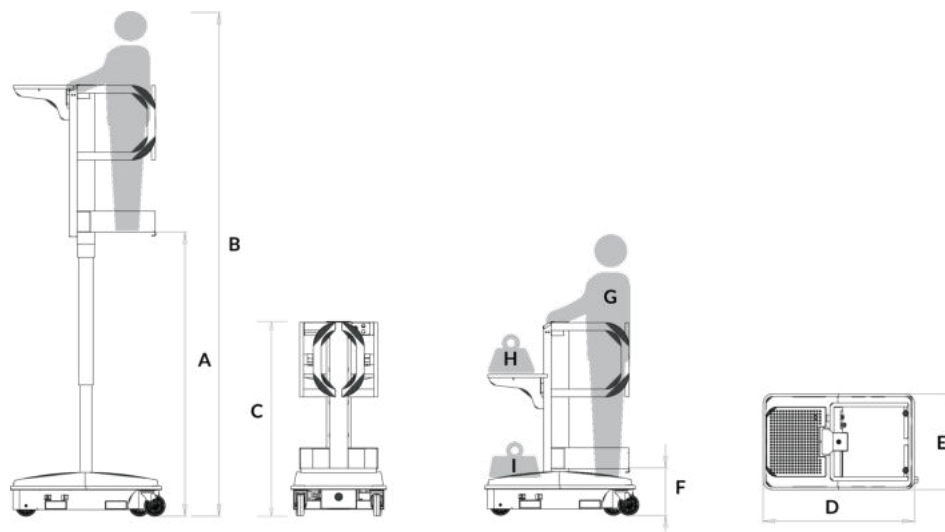

# Sprint



A	11 ft
B	17 ft 6 in
C	4 ft 7 in
D	4 ft 9 in
E	31.9 in
F	14 in
G 	286.6 lbs
H 	198.4 lbs
I 	245 lbs
	1455 lbs
	1
	3.1 mph
	0.7 mph
L	
M	5 ft 2 in
	max. 2%
	110/220 V ca 24Vcc
	n° 4 - 6V; 245Ah@20h







# Spin-Go

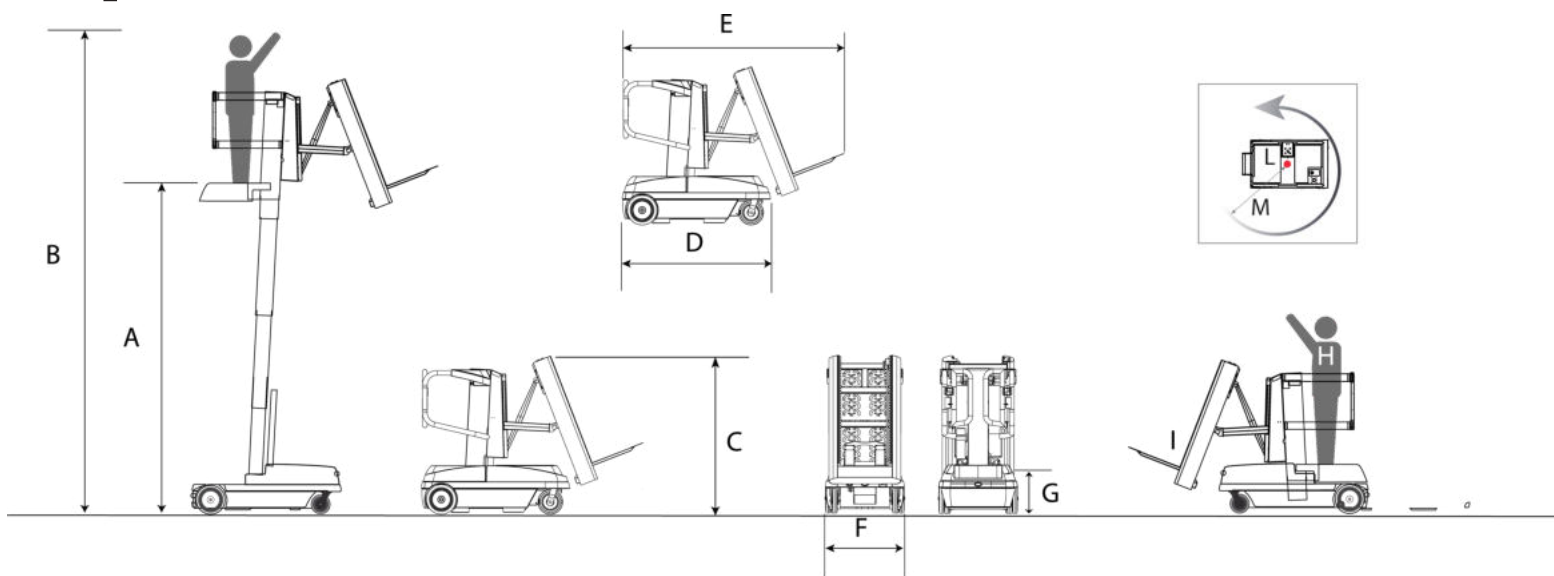

<b>A</b>	7 ft 11 in
<b>B</b>	13 f 67 in
<b>C</b>	4 ft 8 in
<b>D</b>	3 ft 8 in
<b>E</b>	28.7 in
<b>F</b>	14.4 in
<b>G</b> 	286.6 lbs
<b>H</b> 	198.4 lbs
<b>I</b> 	198.4 lbs
	617 lbs
	1
	110/220 V ca 12 Vcc
	N° 1 12V; 85Ah@20h

# Sprint TL



<b>A</b>	11 ft
<b>B</b>	17 ft 6 in
<b>C</b>	5 ft 2 in
<b>D</b>	4 ft 9 in
<b>E</b>	7 ft 3
<b>F</b>	32 in
<b>G</b>	14 in
<b>H</b>	286.6 lbs
<b>I</b>	220.5 lbs
	1750.5 lbs
	1
	3.1 mph
	0.7 mph
<b>L</b>	
<b>M</b>	6 ft 5 in
	max. 2%
	110/220 V ca 24Vcc
	n° 4 - 6V; 245Ah@20h